

SYSTEM DIAGRAM

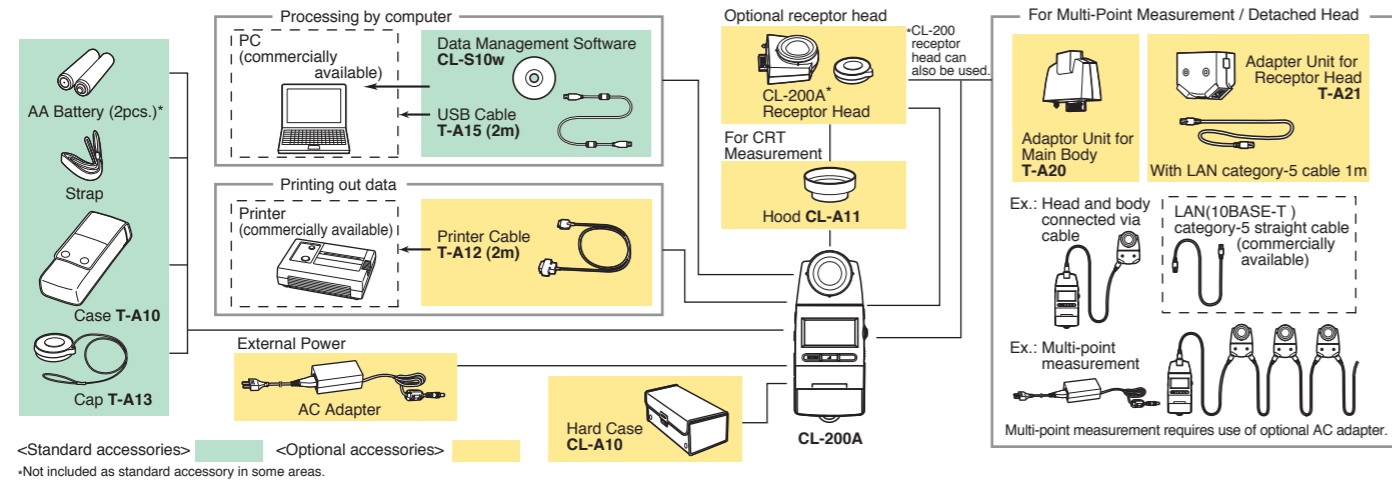

Main specifications of Chroma Meter CL-200A

| | |
|--------------------------------------|---|
| Model | Chroma Meter CL-200A |
| Luminance meter class | Conforms to requirements for Class AA of JIS C 1609-1: 2006 "Illuminance meters Part 1: General measuring instruments" |
| Relative spectral response | Closely matches CIE Standard Observer curves $\bar{x}(\lambda)$, $\bar{y}(\lambda)$, and $\bar{z}(\lambda)$ Within 6% (fi) of the CIE spectral luminous efficiency $V(\lambda)$ |
| Cosine response (f_c) | E_v : Within 3% |
| Receptor | Silicon photocell |
| Measuring function | Tristimulus values: XYZ Chromaticity: E_{vxy} ; $E_{vu'v'}$; E_v , Dominant wavelength, Excitation purity Correlated color temperature: $E_{vT_{cp}}$ Δuv ; T_{cp} (JIS method; available only with CL-S10w) Color difference: $\Delta(XYZ)$, $\Delta(E_{vxy})$, $\Delta(E_{vu'v'})$, $\Delta E_{vu'v'}$ (Target: 1) |
| Other function | User calibration function, Data hold function, Multi-point measurement (2 to 30 points) |
| Measuring range | 0.1 to 99,990 lx, 0.01 to 9,999 fcd (Chromaticity: 5 lx, 0.5 fcd or above) in four automatically selected ranges (lx or fcd is switchable) |
| Accuracy | E_v (Linearity): $\pm 2\% \pm 1$ digit of displayed value xy : ± 0.002 (800 lx, Standard Illuminant A measured) |
| Repeatability | E_v : $0.5\% \pm 1$ digit (2σ), xy : ± 0.0005 (800 lx, Standard Illuminant A measured) |
| Temperature drift | E_v : $\pm 3\% \pm 1$ digit of displayed value, xy : ± 0.003 (Based on Konica Minolta's standard measurement conditions) |
| Humidity drift | E_v : $\pm 3\% \pm 1$ digit of displayed value, xy : ± 0.003 (Based on Konica Minolta's standard measurement conditions) |
| Response time | 0.5 sec. (continuous measurement) |
| Digital output | USB |
| Display | 4-significant-digit LCD with back-light illumination |
| Operating temperature/humidity range | -10 to 40°C, relative humidity 85% or less (at 35°C) with no condensation |
| Storage temperature/humidity range | -20 to 55°C, relative humidity 85% or less (at 35°C) with no condensation |
| Power source | 2 AA-size batteries / AC adapter (optional) |
| Battery life | 72 hours or longer (When alkaline batteries are used) in continuous measurement |
| Dimensions | 69x174x35mm (2-6/16x6-14/16x1-7/13in.) |
| Weight | 215g (7.6 oz.) not including batteries |
| Standard accessories | Case T-A10, Cap T-A13, Strap, AA Batteries (2)*, Data Management Software CL-S10w, USB cable T-A15 *Not included as standard accessory in some areas. |
| Optional accessories | Receptor Head, Adaptor Unit for Main Body T-A20, Adapter Unit for Receptor Head T-A21, AC Adapter AC-A308 (For 1 to 10 receptor heads), AC Adapter AC-A311 (For 1 to 30 receptor heads), Printer Cable T-A12, Hood CL-A11, Hard Case CL-A10 |

Main specifications of Data Management Software CL-S10w

| | |
|------------------------|--|
| Type | Add-in for Excel® * Excel is required to use this add-in. |
| Operating environment | One of the following environments with Excel® installed: Windows® XP + Excel® 2003 (English, Japanese, or Simplified Chinese) Windows® 7 + Excel® 2007 (English, Japanese, or Simplified Chinese) * For details on system requirements for above versions of Windows® and/or Excel®, refer to their respective specifications. * Languages in parenthesis () are the OS language. |
| Compatible instruments | CL-200A, CL-200* * Some functions not usable with CL-200. |

KONICA MINOLTA SENSING, INC.
Konica Minolta Sensing Americas, Inc
Konica Minolta Sensing Europe B.V.

Osaka, Japan
New Jersey, U.S.A.
European Headquarter / BENELUX
German Office
French Office
UK Office
Italian Office
Swiss Office
Nordic Office
Polish Office

Phone : 888-473-2656(in USA), 201-236-4300(outside USA)
Nieuwegein, Netherlands
München, Germany
Roissy CDG, France
Milton Keynes, United Kingdom
Milan, Italy
Dietikon, Switzerland
Västra Frölunda, Sweden
Wrocław, Poland
Shanghai, China
Beijing, China
Guangzhou, China
Chongqing, China
Qingdao, China
Singapore
Seoul, Korea

Phone : +31(0)30 248-1193
+49(0)89 4357 156 0
+33(0)1 493-82519
+44(0)1908 540-622
+39 02 39011.425
+41(0)43 322-9800
+46(0)31 7099464
+48(0)71 33050-01
+86-021-5489 0202
+86-010-8522 1551
+86-020-3826 4220
+86-023-6773 4988
+86-0532-8079 1871
+65 6563-5533
+82(0)2-523-9726



Certificate No. : YKA 0937154
Registration Date : March 3, 1995



Certificate No. : JQA-E-80027
Registration Date : March 12, 1997

SAFETY PRECAUTIONS

For correct use and for your safety, be sure to read the instruction manual before using the instrument.

- Always connect the instrument to the specified power supply voltage. Improper connection may cause a fire or electric shock.
- Be sure to use the specified batteries. Using improper batteries may cause a fire or electric shock.

DIMENSIONS (Units:mm)

With receptor head attached to main body

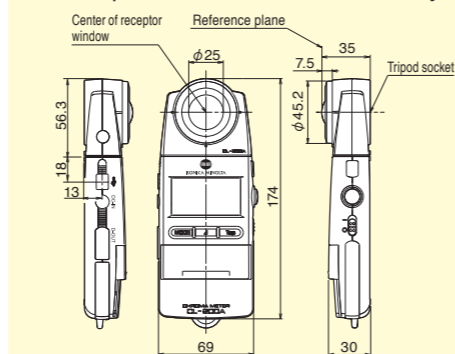

With Adapter Unit attached to receptor head

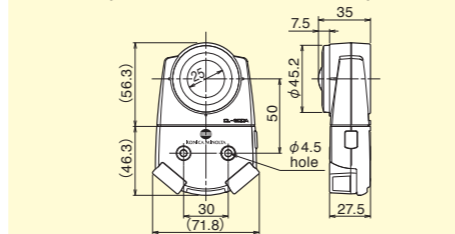

- KONICA MINOLTA and the Konica Minolta logo and the symbol mark, and "The essentials of imaging" are registered trademarks or trademarks of KONICA MINOLTA HOLDINGS, INC.
- Windows® and Excel® are trademarks of Microsoft Corporation in the USA and other countries.
- The specifications and drawings given here are subject to change without prior notice.
- Screens shown are for illustration purpose only.



KONICA MINOLTA

Ideal for measuring color temperature

NEW

Chroma Meter CL-200A

Even measures new light sources such as LED lighting and organic EL lighting



A compact, lightweight instrument with a detachable receptor. Includes convenient, easy-to-use software.

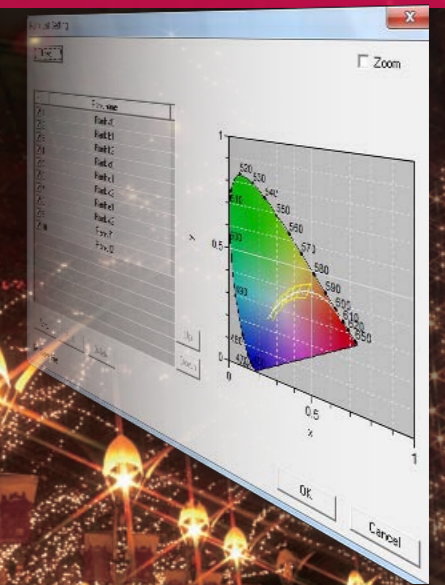

Addresses and telephone/fax numbers are subject to change without notice. For the latest contact information, please refer to the KONICA MINOLTA SENSING Worldwide Offices web page :

<http://konicaminolta.com/instruments/about/network>

©2010 KONICA MINOLTA SENSING, INC.

9242-4876-12 BAGAPK① Printed in Japan

The essentials of imaging

De facto industry standard for measuring color temperature!

Compact and easy to carry

The CL:200A's compact body fits in your palm. Battery-powered so it can be taken along and used anywhere.



Detachable receptor head

The receptor head can be detached and then connected to the main body using a normal LAN cable*, making it easy to install the sensor in an inspection system.

* Optional Adapter Units required for receptor head and main body

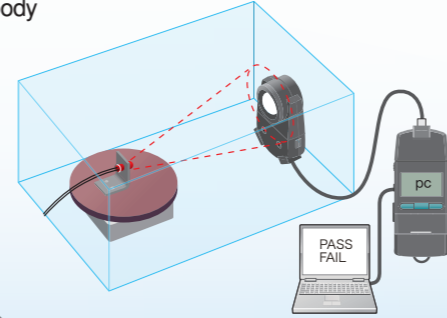

Data transfer using main body buttons

When using the CL-200A with Data Management Software CL-S10w (included), measurements can be taken and data transferred to Excel® using the main body buttons as well as computer keys.

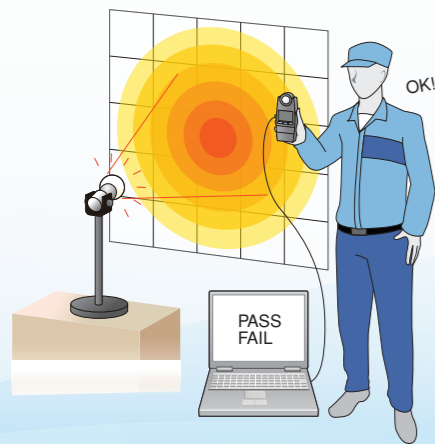

Can also measure illuminance (JIS AA class)

Measures color temperature!



Measures dominant wavelength!



Even measures excitation purity!



Application examples

For lighting production and adjustment

When using various types of light sources in a room or open space, it is sometimes necessary to check the color of the lighting. By using the CL-200A, it is possible to adjust the lighting color so that the food in a restaurant looks delicious.



For evaluating light source characteristics

Evaluation of the light distribution of LED illumination modules or the illuminance distribution of lighting fixtures can be evaluated.

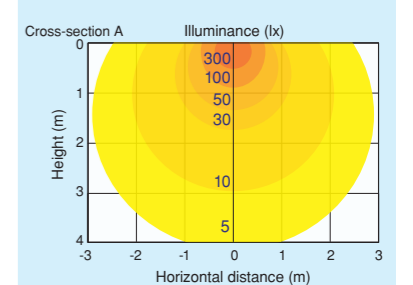

For color-viewing cabinet maintenance

A color-viewing cabinet like that shown at left is used in industries such as the printing industry to visually evaluate finished work under controlled conditions. This color-viewing cabinet provides illumination at a specific illuminance and color temperature by using fluorescent lamps, halogen lamps, etc. The CL-200A can be used for the daily maintenance and control of these lamps as well as to indicate when replacement is needed.



For projector light-source research and color inspection

The CL-200A can be used to measure the white balance and uniformity of microprojectors, etc. with internal LED light sources. The ability to connect multiple receptors using LAN cables enables measurement of not only a single point in the center, but up to a maximum of 30 points over the entire projected area.

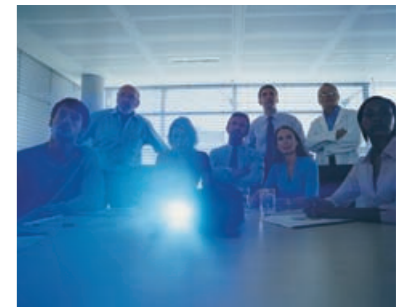

For LED billboard development and maintenance

The CL-200A enables quality control of the LED modules for digital signage to be performed easily. If modules with different color tones are used together, the billboard will look mottled, but by measuring the chromaticity and color temperature of modules using the CL-200A and selecting modules based on measured values, billboard uniformity can be achieved.



Excel® add-in software included

Easy, convenient Excel® add-in

Measurement data from the CL-200A can be transferred directly into Excel®. The transferred data can then be managed freely within Excel®.

Includes LED ranking function

Color variations, the top topic in the LED industry, can be quantified and a ranking function is also provided.

JIS correlated color temperature

Correlated color temperature is determined using the equations defined by JIS (Japanese Industrial Standards).

Multi-point measurement and user calibration also possible

Multi-point measurement management using up to 30 receptor heads is possible.

User calibration function enables compensation of measurement values to match a desired standard. Calibration can be performed by two methods: Single-point calibration or RGB calibration.

Data Management Software CL-S10w (Standard accessory)

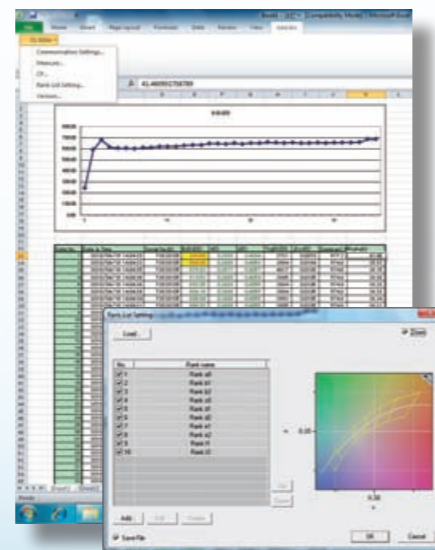

For accurate measurements of color temperature, use the CL-200A!

Measurement accuracies of CL-200A and photographic color meter

When measuring light sources with non-continuous spectrums such as LEDs, etc., accurate illumination color temperature is particularly required. The CL-200A can measure color temperature accurately.

CL-200A

The CL-200A has sensors that closely match the color-matching functions defined by the CIE (International Commission on Illumination), enabling precise color measurement. The measurement results can be displayed in various color notations such as "Correlated color temperature and Δuv " according to the application.

Photographic color meter

In order to take more beautiful pictures, it is sometimes necessary to attach filters in front of the camera lens to compensate for the color of the light illuminating the subject. A photographic color meter is a meter used to select the appropriate filters, with the sensitivity of its sensors adjusted to match that of the film or digital camera sensor. In addition, because it uses photographic color temperature, which is calculated based mostly on the blue/red balance of the illumination, large errors may occur if it is used to measure light sources with non-continuous spectrums.

[Actual measurement data for daylight-color LED bulb]

| | Measured color temperature | Color-temperature difference from standard-instrument measured value |
|-----------------------------------|----------------------------|--|
| Our company's standard instrument | 5045 | 0 |
| CL-200A | 5011 | -34 |
| Photographic color meter | 5600 | 555 |

Color temperature and correlated color temperature

Color temperature

When an ideal blackbody* is heated, it begins to emit light, and as the temperature increases the color of the emitted light changes from red to yellow to white. Since the color of the emitted light is determined by the temperature of the blackbody, the color of the light emitted by the blackbody can be expressed as the absolute temperature of the blackbody (in Kelvin). This color notation scale is called "color temperature". For example, a 7000K color would be the color of the light emitted by a blackbody heated to 7000K. Figure 1 shows the color of light emitted by a blackbody at various temperatures plotted on an xy chromaticity diagram. This curve is called the "blackbody locus"; "color temperature" expresses a color on this blackbody locus.

Correlated color temperature

Since the color of white light emitted by illumination equipment and displays is generally close to the blackbody locus, the color of such light sources is normally expressed using "color temperature".

However, the color of such light sources is not directly on the blackbody locus. Because of this, a way to enable similar color expression for colors within a larger region close to the blackbody locus was devised. This is called "correlated color temperature", and the larger region is shown by the isotherms on the xy chromaticity diagram in Figure 2.

To accurately express the correlated color temperature of a light-source color, it is necessary to state not only the correlated color temperature but the difference from the blackbody locus, normally in terms of Δuv .

*Blackbody
An ideal radiator. A body which completely absorbs all incident electromagnetic radiation. Although a perfect blackbody does not actually exist, coal is a familiar object that acts similarly.

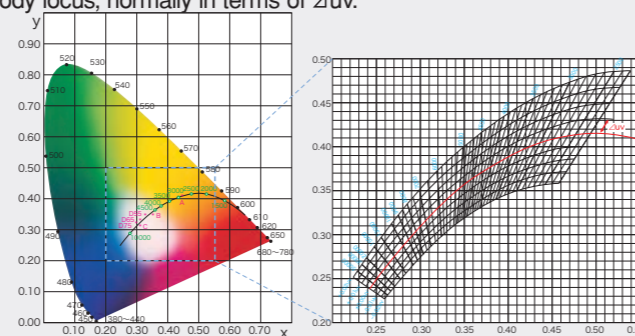

Figure 1: Blackbody locus on xy chromaticity diagram

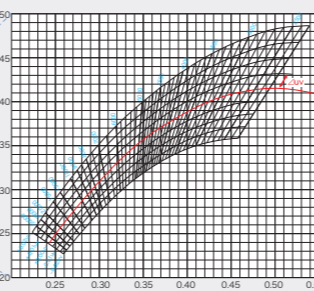

Figure 2: Closeup of blackbody locus on xy chromaticity diagram showing correlated color temperature region

General Reference Information Measurements in the LED manufacturing process

When made from blue LED and phosphor

The blue light emitted by the LED mixes with the yellow light emitted by the phosphor to create white light.

Problem:

Since the spectral emission distribution of the blue light emitted by the LED varies for each unit, variations in the resulting white light will occur. Since usually LED lamps use several LEDs, control of color mixing is necessary.

General solution:

- ① Measure the spectral emission characteristics of each LED element and rank them accordingly.
- ② Measure the emission characteristics of the phosphor and rank accordingly.
- ③ Combine the ranked LED elements and ranked phosphor materials to achieve the desired white light.
- ④ Inspect the output light quality of the final assembled white LED lamp.

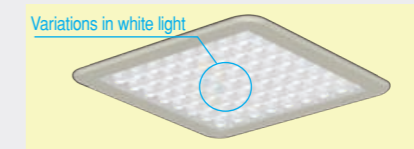
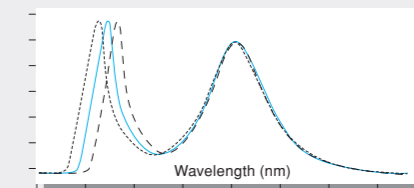
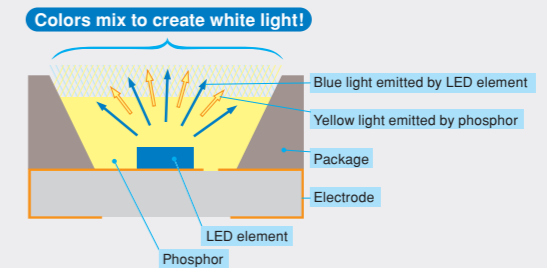

How the CL-200A can help:

The CL-200A can measure the chromaticity from the phosphor and also inspect the output light quality of the final assembled white LED lamp.

LED total flux measurement system

- This system combines our top-of-the-line Spectroradiometer CS-2000 modified for illuminance measurement with an LED total flux measurement adapter to create an LED measurement system that utilizes a spectral measuring instrument conforming to CIE 122:1996 as the receptor. The total flux emitted in all directions by the LED is diffused by the integrating sphere and received for measurement by the spectroradiometer.
- This system conforms to CIE 127:2007.
- Since the spectral response of the receptor matches the CIE spectral luminous efficiency function $V(\lambda)$, there is no need to perform troublesome color correction.
- To enable accurate measurements, a self-absorption compensation function is provided to compensate for the reduction in integrating sphere output due to self absorption of the light source when it is lit inside the integrating sphere.

